

MAX-FLOW



MAX FLOW

Electric Machinery CO., LTD.

Fan Manufacturer of Taiwan

AC	DC	FILTER
<p>AC AXIAL FAN <u>MF25090 (250x90mm)</u> <u>MF17251R (Ø172mm)</u> <u>MF17251 (172x51mm)</u> <u>MF12038 (120x38mm)</u> <u>MF12025 (120x25mm)</u> <u>MF 9225 (92x25 mm)</u> <u>MF 8038 (80x38 mm)</u> <u>MF 8025 (80x25 mm)</u></p> <p>IP55 AC FAN <u>MF17251 (172x51mm)</u> <u>MF12038 (120x38mm)</u></p> <p>Capactor Fan Motor <u>MFC28080(280x80mm)</u> <u>MFC22068(220x68mm)</u> <u>MFC20572(205x72mm)</u> <u>MFC18066(180x66mm)</u> <u>MFC16066(160x66mm)</u></p>	<p>DC FAN (25/40/50mm) <u>2507</u> <u>4007 4010 4020</u> <u>5010 5015</u></p> <p>DC FAN (60/70mm) <u>6010 6015 6020 6025</u> <u>7010 7015 7020 7025</u></p> <p>DC FAN (80/90mm) <u>8015 8020 8025</u> <u>8030Blower 9225</u></p> <p>DC FAN (120/172mm) <u>12025 12038</u> <u>17251Ellipse Frame</u> <u>17251Round Frame</u></p>	<p>MU SERIES <u>MU-04 (163x27mm)</u> <u>MU-06 (204x26mm)</u> <u>MU-9703 (158x25mm)</u> <u>MU-9704 (208x25mm)</u></p> <p>MA SERIES <u>MA-04 (148.5x13.5mm)</u> <u>MA-06 (204x13.5mm)</u> <u>MA-08 (255x13.5mm)</u></p> <p>Accessories <u>AC CORD</u> <u>WIRE FORM FINGER</u> <u>PLASTIC FILTER</u></p>

No 19, Lane 349, Hwa Cheng Rd., Hsin Chang City, Taipei Huian, Taiwan, R. O. C.

Tel:886-2-85218198 Fax:886-2-85218201 Email:muya@ms5.hinet.net

Accessories Product Series

Ac Cord

Power cord with straight connector

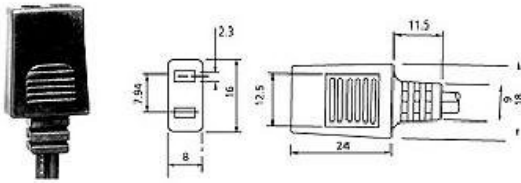

Type Straight 180*

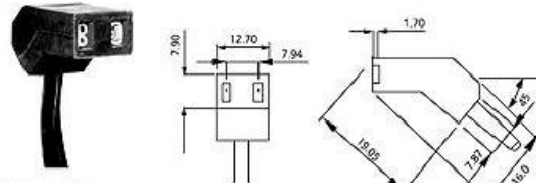

Type 45*

Model	C - 180	C - 45
Length	900mm	900mm

Plastic Filter Guard

- Consist of a guard, filter media and retainer
- Installation is quick and simple
- UL 94V-0 material

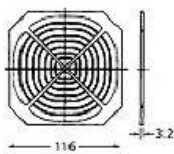
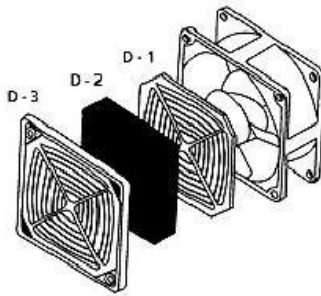

Retainer

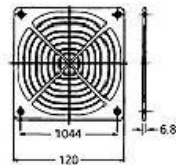

Finger Guard

Part No.	D - 1	D - 2	D - 3
Description	Guard	Filter	Remainer

Wire Form Finger Guard

Wire Form Finger Guard is designed to ensure safe operation and meet UL.25 dia plug gage test. Nickle chrome plating standard finish.

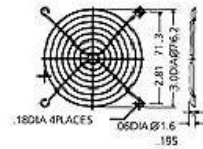

FG-80 3 1/8"

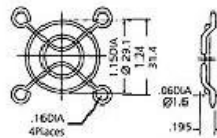

FG-40 1 1/2"

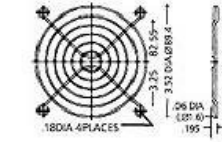

FG-92 3 5/8"

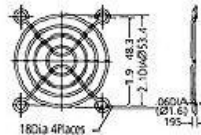

FG-60 2 3/8"

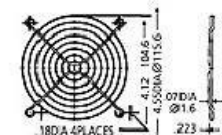

FG-120 4 1/2"

按裝方式 Install Method

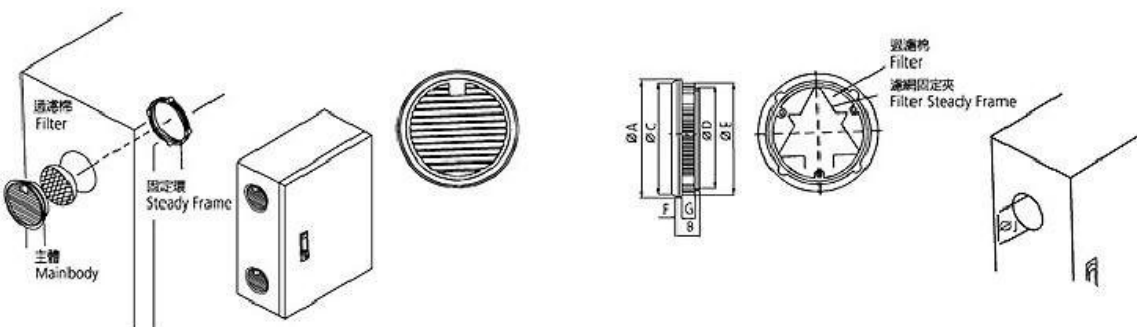

安裝方式 Install Method

